

- Practical guide
- Stock Range Specifications
- How to choose and specify the perfect Umbrella



Connecting Brands With People

Preseli has been a supplier of popular products to the promotional industry since 1992. During 30 years of trading, we have built our reputation on great service and time-proven reliability.

Our business is delivering our customers' promises on every order, from large to small.

We are a subsidiary company of Preseli Merchandising based in Hong Kong. Their team of experienced merchandisers and logistics personnel ensure that our orders are supplied on time and to specification.

Umbrellas have always been a popular product so we like to think we are well placed to help customers get the right product at the best price. Our Stock range meets the demands of the most exacting client and can be customised quickly here in the UK.

We do also offer a fully bespoke design service if required, contact us for more details.

Whether your customer is a local community group or business, a start up or an established blue chip corporation, Preseli is equipped and ready to receive your order and manage it through every process, from conception to final delivery.



1. CHOOSING YOUR UMBRELLA

The Basics, Leadtimes, End
Uses & Design options
Pg 4-7

2. FIBREGLASS STORM

Classic all-rounder
Pg 8-9

3. VENTED

The perfect golf umbrella
Pg 10-11

4. AUTO VENTED

The top of the range
Pg 12-13

5. COMPACT MINI

For day to day use
Pg 14-15

6. TEMPLATES

Print and Size Information
Pg 22-23



Preseli Umbrellas

A QUALITY GIFT ITEM

- Umbrellas have long been associated with premium brand promotion.
- Made by the foremost manufacturer in the industry
- Add a touch of class to any function or business

LONG LASTING BRAND PROMOTION

- Umbrellas are the perfect promotional item
- Long lasting consumer usage
- Association with premium sporting events
- Long product life for brands who want to distance themselves from single use plastics

QUICK TURNAROUND

- Preseli's umbrellas are held in UK stock
- Plain stock can be delivered next day or branded within 10 working days

ESSENTIAL UK KIT

- A great team accessory for fund raisers who want to attend events in all weathers
- Essential for any UK outdoor event at *ANY* time of the year

Internal ribs are made of strong and flexible materials to give maximum strength in windy conditions

Rigid main shaft is made from of super strong material to make a long lasting promotional item

Whichever style you choose handles are designed to be comfortable and practical

Plain stock can be delivered on our Next Day service



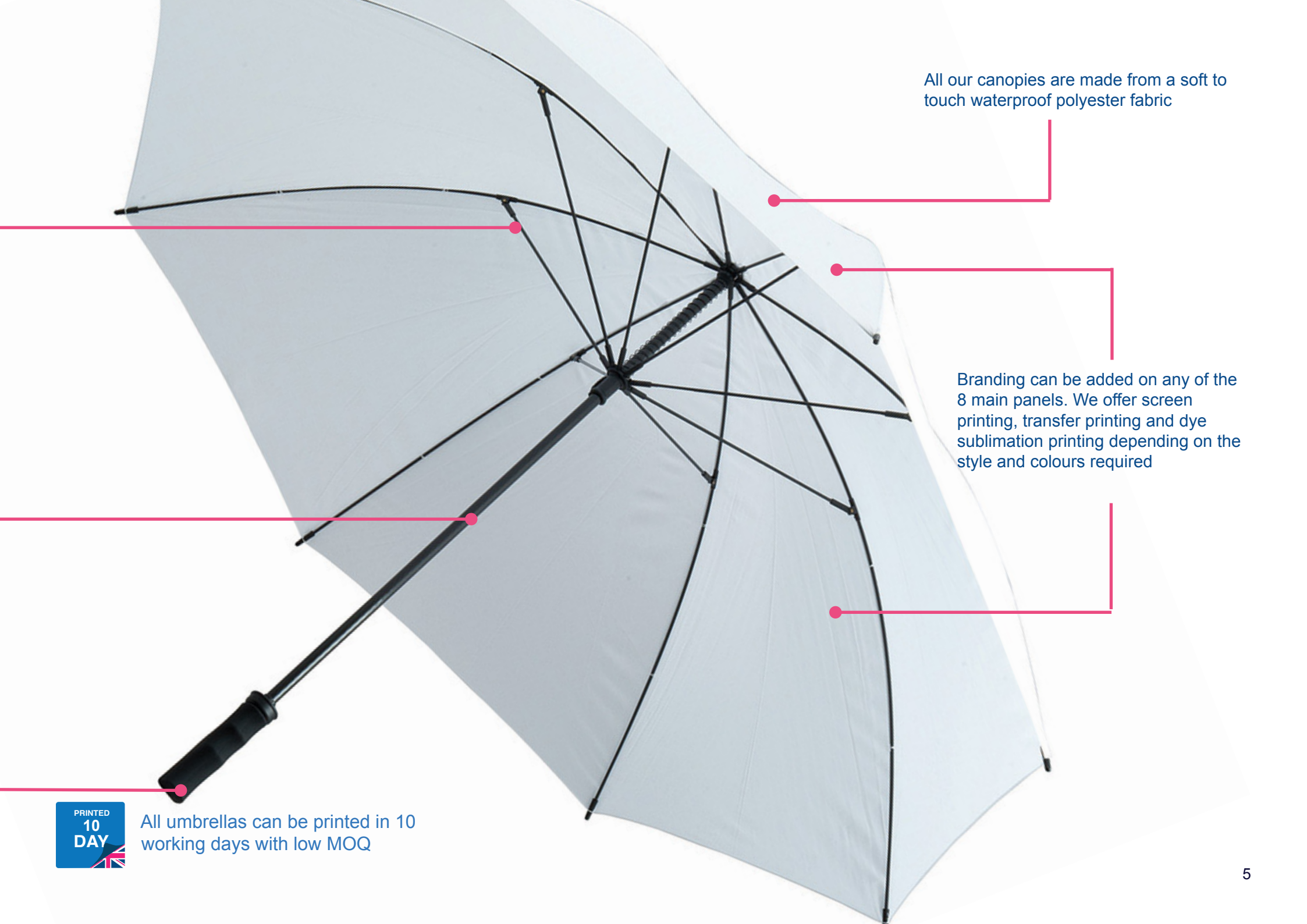

All our canopies are made from a soft to touch waterproof polyester fabric

Branding can be added on any of the 8 main panels. We offer screen printing, transfer printing and dye sublimation printing depending on the style and colours required

PRINTED
10
DAY

All umbrellas can be printed in 10 working days with low MOQ

2. WHY SOURCE YOUR UMBRELLAS FROM PRESELI?

1

QUICK TURNAROUND UK STOCK

We hold bulk quantities in stock ready for next day delivery, perfect for those events dependent on the UK's famously changeable weather

Any stock item can be customised to your design in 8-10 working days

2

INDUSTRY PROVEN QUALITY

Our Umbrellas are made in bulk by one of the most respected suppliers in the industry.

Our low MOQs and quick turn around printing allow customers to access a proven high quality product without the need for custom made leadtimes.

Trusted for their promotions by many of the UK's leading brand names.

3

EASY CUSTOMISATION

Use our simple templates to add your clients design to any of our stock lines.

Simple designs can be screen printed with ease.

More complicated designs with lots of detail or colours can be Transfer or Sublimation printed.

Transfer prints can be on any colour, sublimation on white only.

4

EXCELLENT SERVICE

We can provide high quality visuals to help you win that prestige order.

Preseli are an award winning supplier for customer service who have been driving the promotional trade for over 30 years.

Trust us to deliver your requirements on time and to the highest quality standards.

NOW FIND YOUR STYLE.....

FIBREGLASS STORM

Our best selling classic umbrella

The Fibreglass Storm Umbrella is our best selling model and is supported by stock in 11 colours. This classic 30 inch design is available in both solid colour and 2 color options.

Preseli umbrellas are held in UK stock and can be printed with your design in 10 working days with low minimum orders. No MOQ for plain stock.

Features

- Classic 8 Panel design
- Strong fibreglass shaft
- Thick fibreglass ribs
- Rubberised pistol style grip
- Soft feel Polyester pongee canopy

Specifications

- Open size 1300mm x 975mm
- Size for postage 106cm x 5.5cm x 5.5cm
- Weight 560g

Printing

- All colour panels can be screen printed
- All colour panels can be transfer printed
- White panels can be Dye sublimation printed
- For print areas see pages 16-17



FIBREGLASS STORM



Black
UMS03



Navy
UMS07



Blue
UMS08



Green
UMS06



Red
UMS01



White
UMS04



Black/White
UMS0304



Navy/White
UMS0704



Blue/White
UMS0804



Green/White
UMS0604



Red/White
UMS0104



All umbrellas can be printed in
10 working days with low MOQ

Plain stock can be delivered
on our Next Day service



VENTED

The classic golf style umbrella

The Vented Golf Umbrella is a best selling model and is supported by stock in 7 colours. Its vented canopy makes it easier to use in windy conditions which is why its so popular with golfers.

This classic 30 inch design is available in both solid colour and 2 color options.

Preseli umbrellas are held in UK stock and can be printed with your design in 10 working days.
No MOQ for plain stock.

Features

- Vented 8 Panel design
- Strong fibreglass shaft
- Thick fibreglass ribs
- Rubber golf style grip
- Soft feel Polyester pongee canopy

Specifications

- Open size 1340mm x 980mm
- Size for postage 106cm x 5.5cm x 5.5cm
- Weight 705g

Printing

- All colour panels can be screen printed
- All colour panels can be transfer printed
- White panels can be Dye sublimation printed
- For print areas see pages 16-17

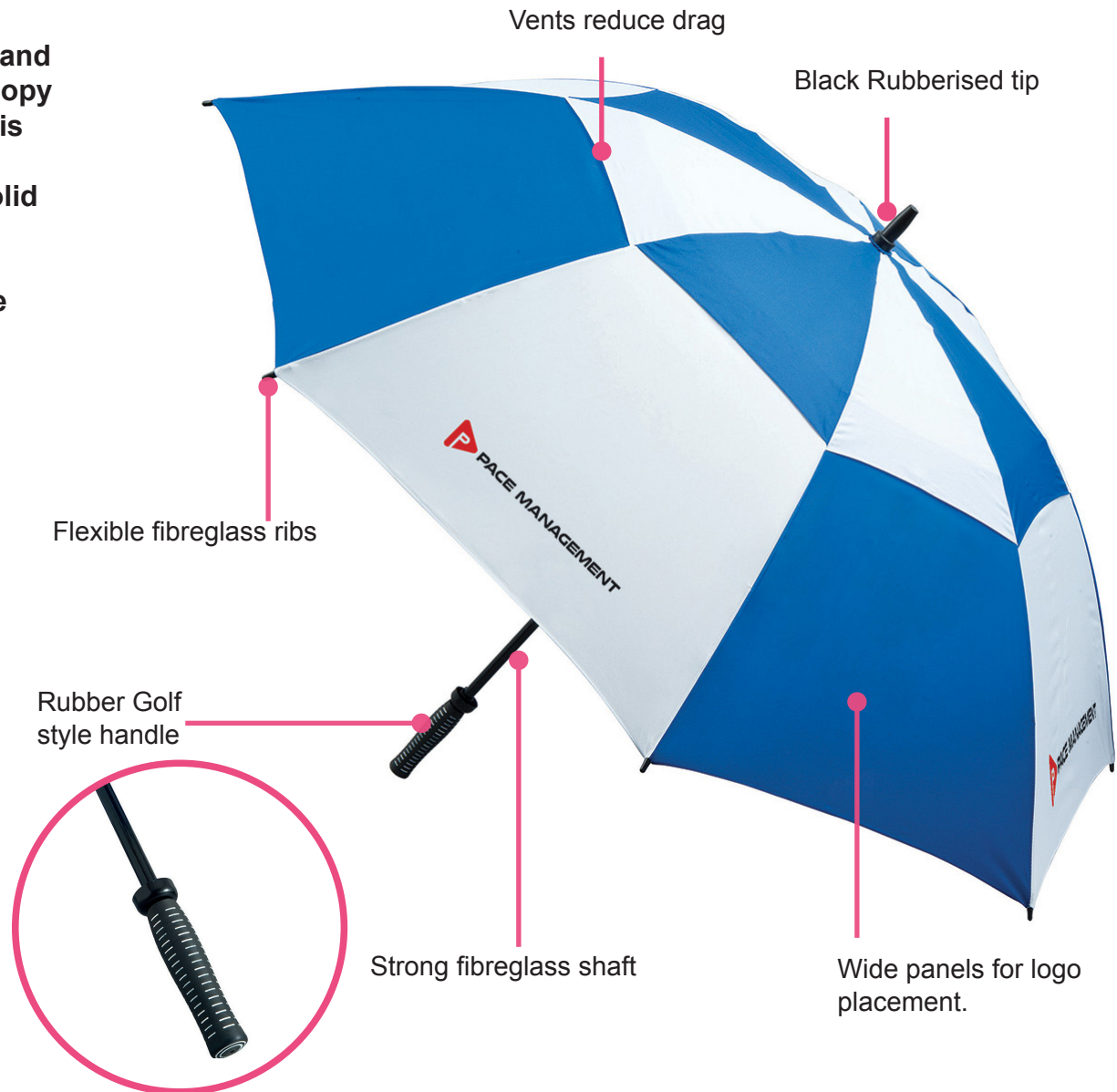



Black
UMV03



Navy
UMV07



White
UMV04



Plain stock can be delivered on our Next Day service



All umbrellas can be printed in 10 working days with low MOQ



Black/White
UMV0304



Navy/White
UMV0704



Blue/White
UMV0804



Red/White
UMV0104

AUTO VENTED

Our top specification model

The Auto Vented Umbrella is our premium model and it features the same canopy design as our Vented model but with the additional upgrade of automatic opening mechanism. This classic 30 inch design is available only in solid colour.

Preseli umbrellas are held in UK stock and can be printed with your design in 10 working days with

Features

- Vented 8 Panel design
- Auto opening
- Strong fibreglass shaft
- Thick fibreglass ribs
- Rubber golf style grip
- Soft feel Polyester pongee canopy

Specifications

- Open size 1340mm x 1000mm
- Size for postage 106cm x 5.5cm x 5.5cm
- Weight 680g

Printing

- For flat colour and simple logos all colour panels can be screen printed
- For full colour and more detailed logos all colour panels can be transfer printed
- For print areas see pages 16-17





Black
AUTO03



Navy
AUTO07



Plain stock can be delivered on our Next Day service



All umbrellas can be printed in 10 working days with low MOQ

COMPACT MINI

The perfect everyday carry

The Compact Mini Umbrella is designed as an everyday carry, giving brands a chance to reach a wider audience. This classic 22 inch design is available in both solid colour and 2 color options.

Preseli umbrellas are held in UK stock and can be printed with your design in 10 working days. No MOQ for plain stock.

Features

- Smaller 8 Panel design
- Strong steel shaft
- flexible steel ribs
- Simple locking handle with wrist loop
- Soft feel Polyester pongee canopy

Specifications

- Open size 970mm x 565mm
- Size for postage 25cm x 5.5cm x 5.5cm
- Weight 540g

Printing

- All colour panels can be screen printed
- All colour panels can be transfer printed
- White panels can be Dye sublimation printed
- For print areas see pages 16-17

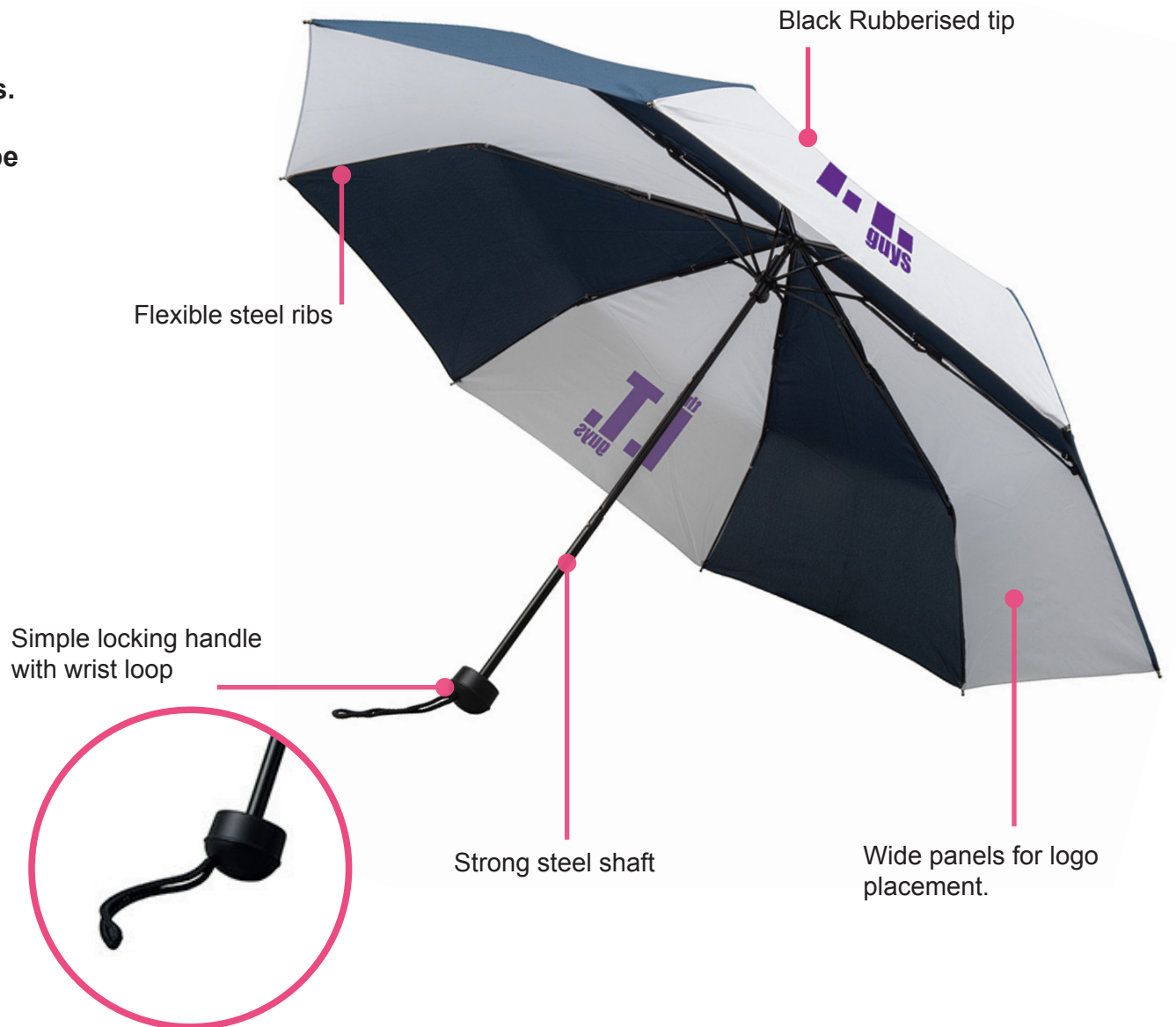

COMPACT MINI



Black
WHU03



Black/White
WHU0304



Navy/White
WHU0704



All compact umbrellas come with their own sleeve for storage. Keeping the wet umbrella away from the other contents of your bag.



Plain stock can be delivered on our Next Day service



All umbrellas can be printed in 10 working days with low MOQ

TEMPLATES

SCREEN PRINTED LOGOS

- Best for solid colour logos
- Any of the 8 panels, white or coloured
- Size restricted to allow room for screen during printing

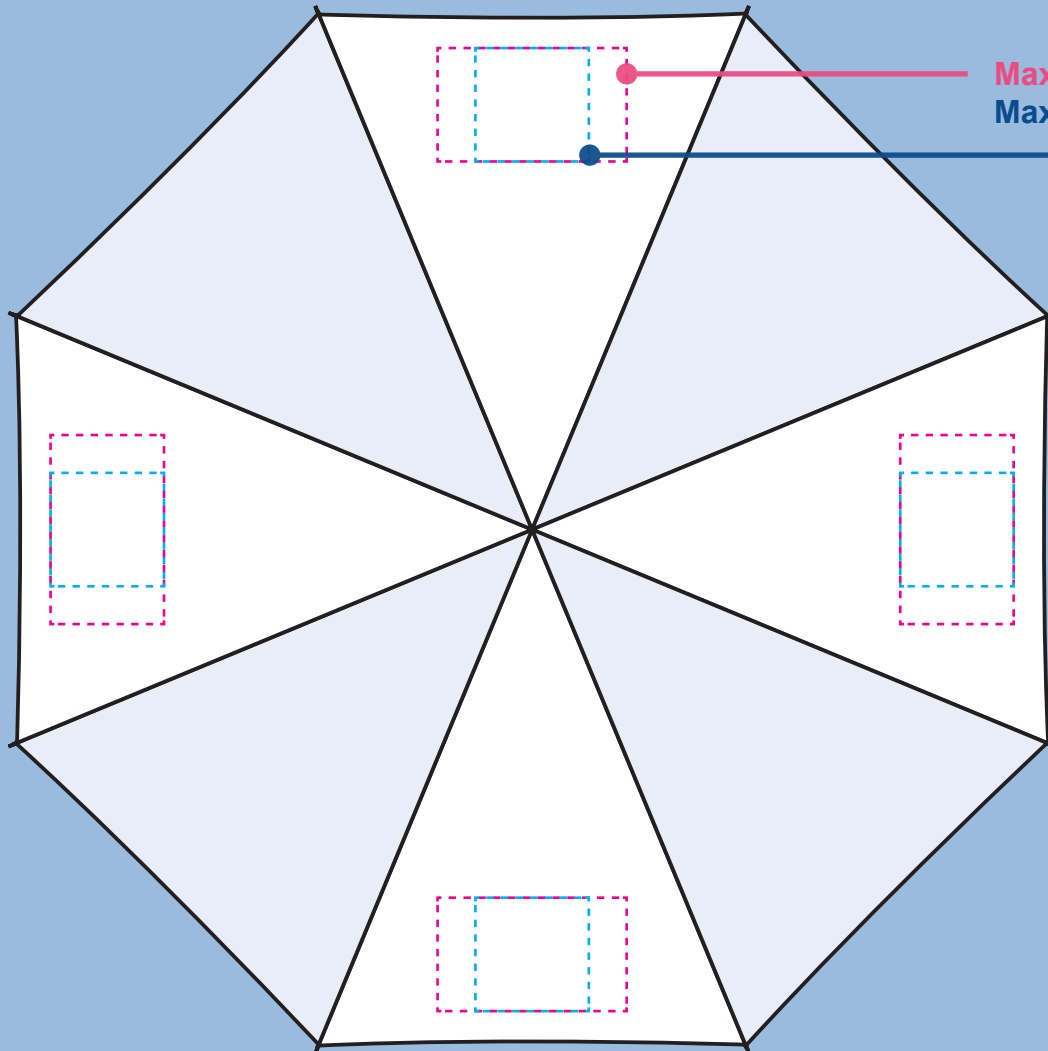

Maximum print area 250 x 150mm (landscape)
Maximum Print area 150 x 150mm (portrait)

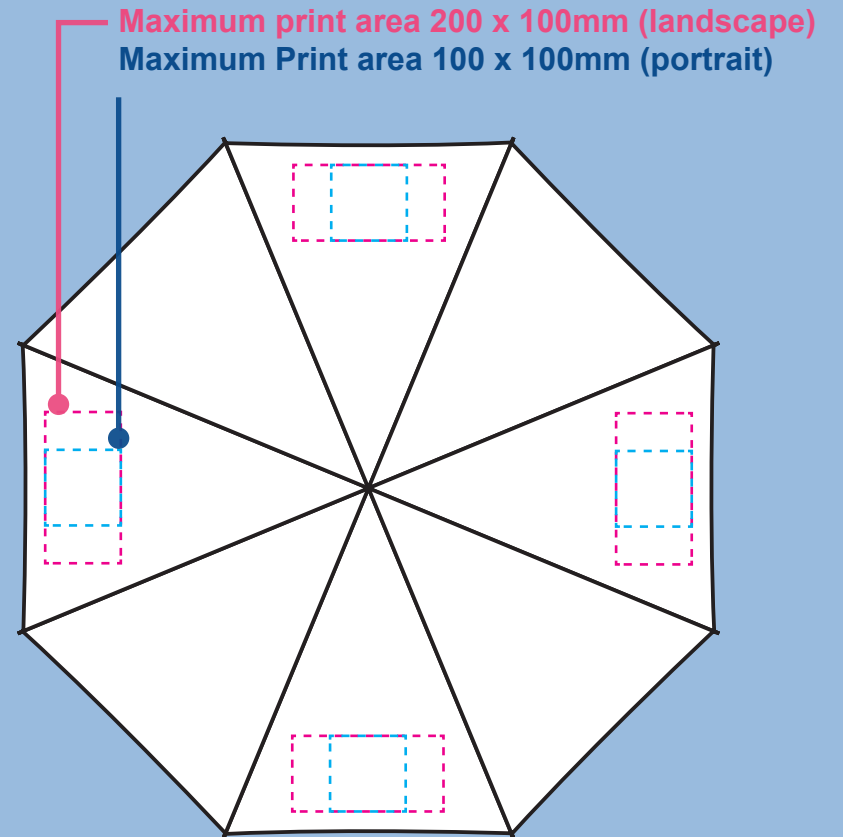

Maximum print area 200 x 100mm (landscape)
Maximum Print area 100 x 100mm (portrait)

STORM & VENTED MODELS

COMPACT MODELS

ARTWORK SIZES FOR UK STOCK UMBRELLAS

- Best for full colour or fine detail logos
- Transfer prints suitable for any of the 8 panels, white or coloured
- Dye Sublimation prints only suitable on White panels
- Larger print area available than screen prints

FULL COLOUR PRINT LOGOS

Maximum print area 297 x 210mm (landscape)
Maximum Print area 210 x 297mm (portrait)

Maximum print area 220 x 120mm (landscape)
Maximum Print area 120 x 120mm (portrait)

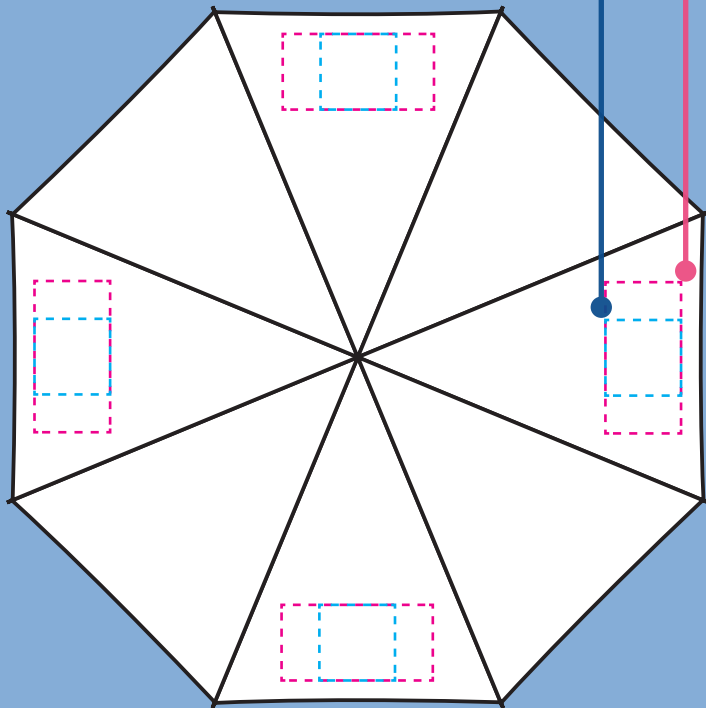

COMPACT MODELS

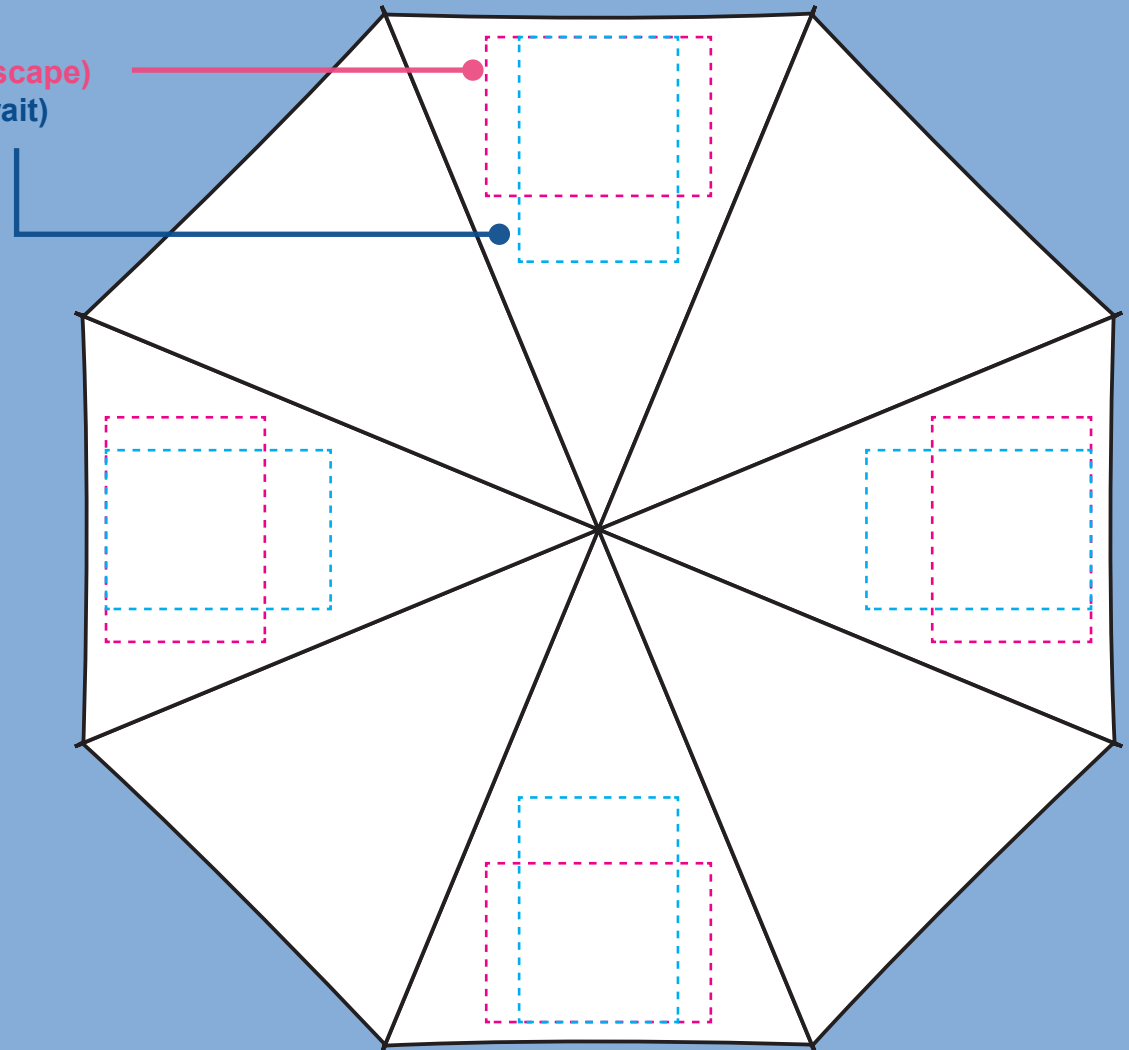

STORM & VENTED MODELS

Preseli Product guides are designed to be a useful tool for staff training and better understanding of ordering specific product areas. They reflect our 30 years of expertise in promotional products and will help you and your customers find the perfect product for their requirements

If you require extra hard copies or digital versions please speak to us and we will be happy to organise it for you.



Connect with us
On the web: preseli.biz
By phone: 01352 730 006
By email: sales@preseli.biz

